



Powerlux Technology Co., Ltd.



Powerlux PLX-LX1XX 1W Power LED Emitter Technical Datasheet Version: 1.5

Introduction

Powerlux Emitter is one of the highest flux performance High Power LED packages in the world. It boasts minimum flux of 70lm and maximum at 110lm for white LED.

Powerlux Emitters can be purchased in reels for high volume assembly.

For high volume applications, custom Powerlux Power LED module designs are available upon request, to meet your specific needs.

Features

- High Flux per LED
- Very long operating life (up to 100k hours)
- Available in White, Warm White, Green, Blue, Amber, Red
- Lambertian or Collimated Radiation Pattern
- More Energy Efficient than Incandescent and most Halogen lamps
- Low Voltage DC operated
- Cool beam, safe to the touch
- Instant light (less than 100ns)
- No UV
- Superior ESD protection
- Soldering methods: IR reflow soldering
- ROHS compliant

Typical Applications

- Reading lights (car, bus, aircraft)
- Portable (flashlight, bicycle)
- Decorative / Entertainment
- Sign and Channel Letter
- Indoor/Outdoor Commercial
- Downlighters
- Automotive Exterior (Stop-Tail-Turn, CHMSL, Mirror Side Repeat)
- LCD backlight

Mechanical Dimensions

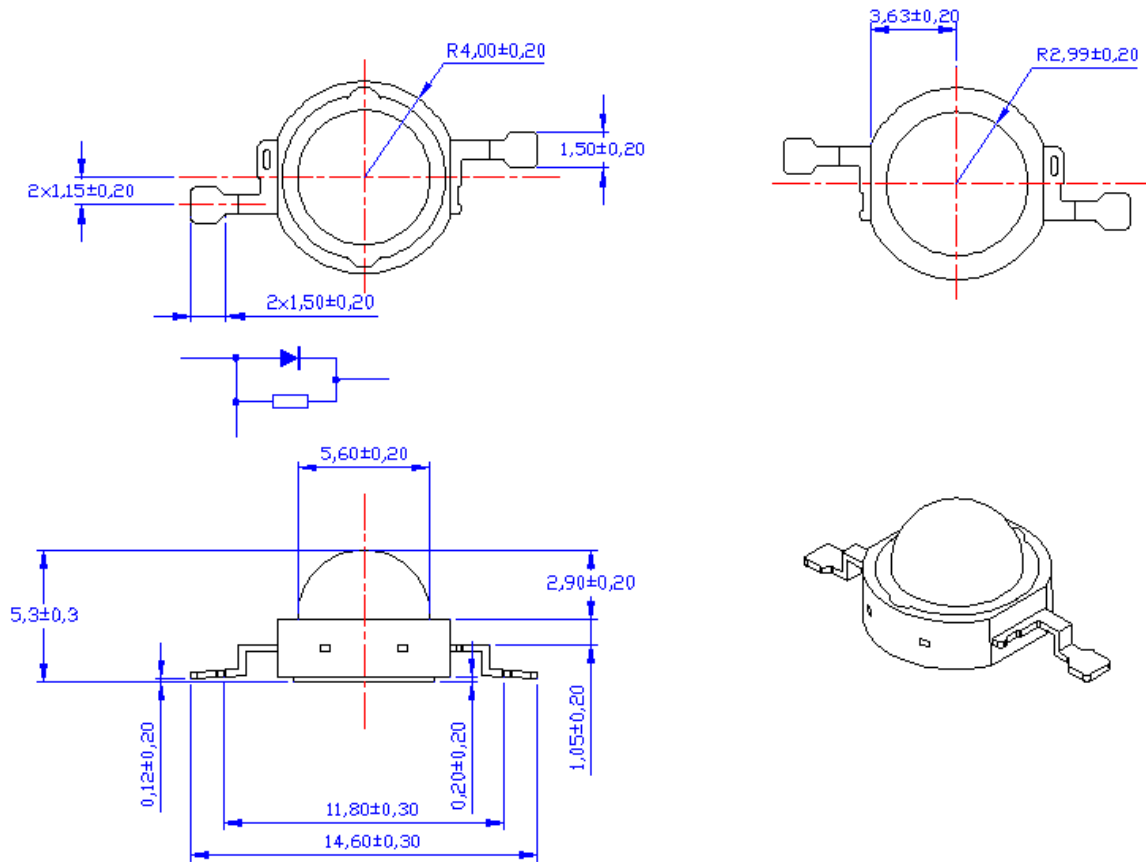

Notes:

1. The Anode side of the device is denoted by a hole in the lead frame.
2. It's important that the slug can't contact aluminum surface, it's strongly recommended that there should coat a uniform electrically isolated heat dissipation film on the aluminum surface.
3. Drawing not to scale.
4. All dimensions are in millimeters.
5. All dimensions without tolerances are for reference only.

Part Number Matrix

Color	Emitter	Remark	Beam Pattern
White	PLX-LW1A0	Typ. CRI 75	
Warm White	PLX-LS1A2	Typ. CRI 80	
Green	PLX-LG1AN		
Blue	PLX-LB1AN		Lambertian
Red	PLX-LR1AN		
Amber	PLX-LA1AN		
Royal Blue	PLX-LP1AN		

Flux Characteristics at 350mA, Junction Temperature, T_j=25°C

Color	Minimum Luminous Flux (lm)	Typical Luminous Flux (lm)	Beam Pattern
White	70.0	80~100	
Warm White	55.0	65	
Green	55.0	70	Lambertian
Blue	15	20	
Red/Amber	40/40	45/45	
Royal Blue	250mw	300mw	

Optical Characteristics at 350mA, Junction Temperature, T_j=25°C

Color	Dominant Wavelength λ_D			Spectral Half-width (nm) $\Delta\lambda_{1/2}$	Temperature Coefficient or Dominant Wavelength $\Delta\lambda_D/\Delta T_j$ (nm/°C)
	Min.	Typ.	Max.		
White	5000K	6000K	7000K	-	-
Warm White	2600K	2850K	3250K	-	-
Green	515nm	525nm	535nm	35	0.04
Blue	460nm	465nm	475nm	25	0.04
Red	615nm	623nm	630nm	20	0.05
Royal Blue	440nm	-	460nm	25	0.04
Amber	585nm	590nm	595nm	20	0.05

Color	Beam Pattern	Total Included Angle $\theta_{0.9v}$ (degree)	Viewing Angle $2\theta_{1/2}$ (degree)	Typical Candela on Axis (cd)
White		160	140	
Warm White		160	140	
Green	Lambertian	160	140	NA
Blue		160	140	
Red/Amber		160	140	
Royal Blue		160	140	

Electrical Characteristics at 350mA, Junction Temperature, T_j=25°C

Color	Forward Voltage Vf(V)			Temperature Coefficient of Vf(mV/°C) ΔVf/ΔT _j	Thermal Resistance Junction to Board(°C/W)
	Min.	Typ.	Max.		
White	3.00	-	3.80	-2	10
Warm White	3.00	-	3.80	-2	10
Green	3.00	-	3.80	-2	10
Blue	3.00	-	3.80	-2	10
Red/Amber	2.00	-	3.00	-2	10
Royal Blue	3.00	-	3.80	-2	10

Absolute Maximum Ratings

Parameter	White/Warm White/Red/Green/Blue/Amber
DC Forward Current (mA)	350
Peak Pulsed Forward Current (mA)	500
Average Forward Current (mA)	350
ESD Sensitivity	4000V HBM
LED Junction Temperature (°C)	125
Storage & Operating Temperature(°C)	-40 to +100
Soldering Temperature(°C)	260 for 10 seconds Max.

Photometric Luminous Flux Bin Structure

Bin Code	Minimum Photometric Flux (lm)	Maximum Photometric Flux (lm)
L	11	14
M	14	18
N	18	23
P	23	30
Q	30	40
R1	40	45
R2	45	50
S1	50	55
S2	55	65
T1	65	75
T2	75	90
U1	90	110
V1	110	130
V2	130	150
W1	150	180

- Tolerance on each Luminous Flux bin is ± 15%

Color Bins for Red

Bin Code	Minimum Dominant Wavelength (nm)	Maximum Dominant Wavelength (nm)
R10	620	625
R20	625	630
R30	630	635

- Tolerance on each Color bin is ± 1 nm

Color Bins for Green

Bin Code	Minimum Dominant Wavelength (nm)	Maximum Dominant Wavelength (nm)
G10	520	525
G20	525	530
G30	530	535

- Tolerance on each Color bin is ± 1 nm

Color Bins for Royal Blue and Blue

Bin Code	Minimum Dominant Wavelength (nm)	Maximum Dominant Wavelength (nm)
P10	450	455
P20	455	460
B10	460	465
B20	465	470
B30	470	475

- Tolerance on each Color bin is ± 1 nm

Color Bins for Amber

Bin Code	Minimum Dominant Wavelength (nm)	Maximum Dominant Wavelength (nm)
A2A	585	587.5
A2B	587.5	590
A3A	590	592.5
A3B	592.5	595

- Tolerance on each Color bin is ± 1 nm

White Light Series Binning Overview

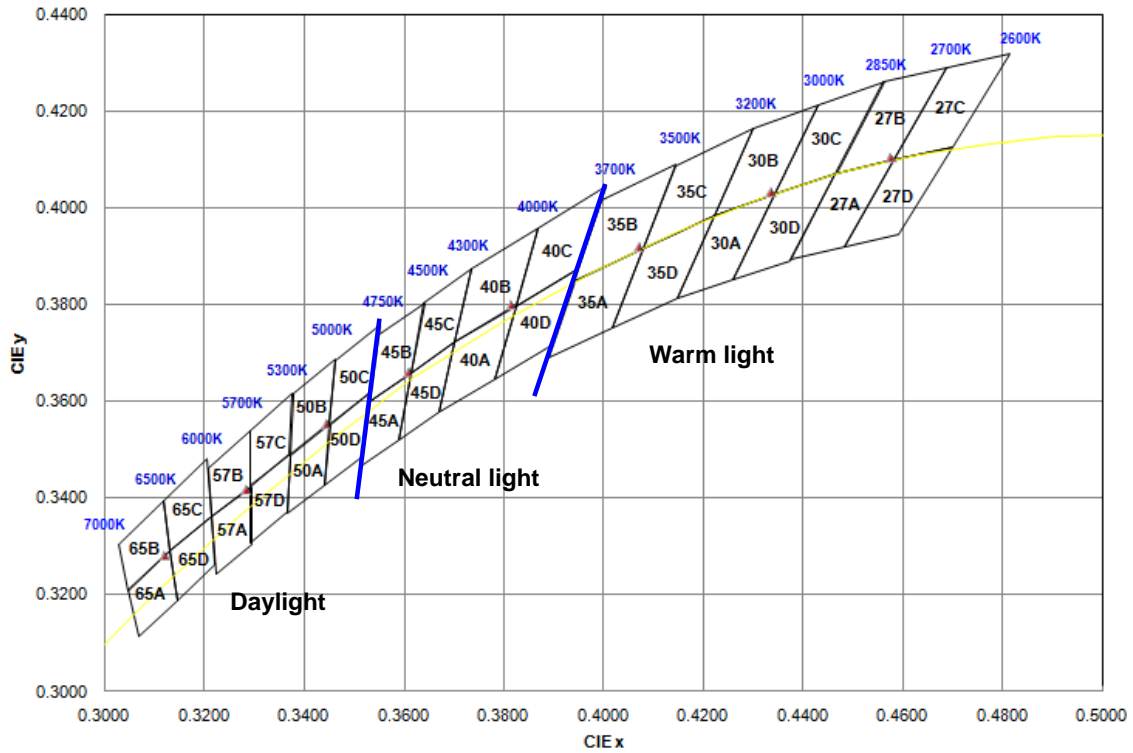

V_f Binning

Unit : (V)

Forward Voltage Bin Code	Range	
	Min.	Max.
V18	1.8	2
V20	2	2.2
V22	2.2	2.4
V24	2.4	2.6
V26	2.6	2.8
V28	2.8	3
V30	3	3.2
V32	3.2	3.4
V34	3.4	3.6
V36	3.6	3.8
V38	3.8	4
V3X	3	3.6



Daylight Binning (4750~7000K)

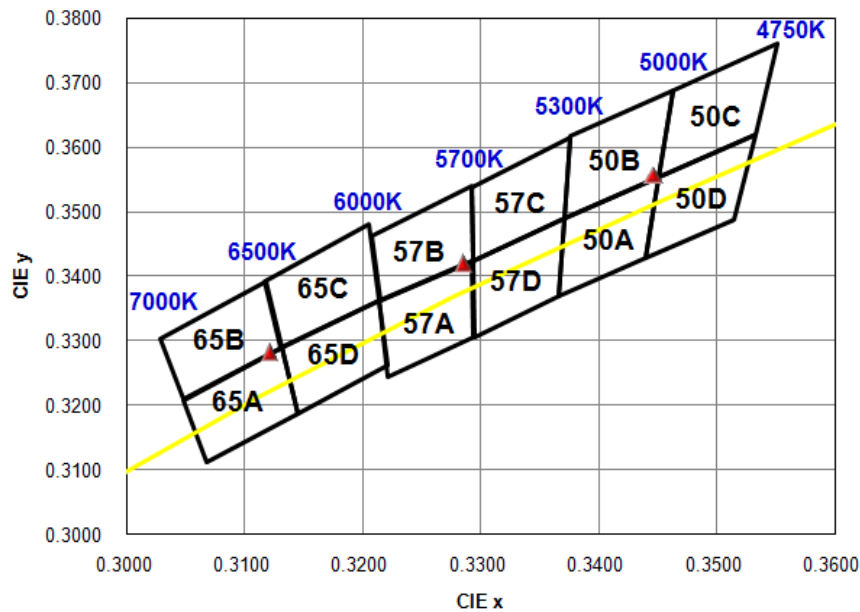

	x	y
65A	0.3068	0.3113
	0.3048	0.3209
	0.3131	0.329
	0.3145	0.3187
65B	0.3048	0.3209
	0.3028	0.3304
	0.3117	0.3393
65C	0.3131	0.329
	0.3117	0.3393
	0.3205	0.3481
	0.3214	0.3362
65D	0.3145	0.3187
	0.3131	0.329
	0.3214	0.3362
	0.3221	0.3261
57A	0.3222	0.3243
	0.3214	0.3362
	0.3293	0.3424
	0.3294	0.3306
57B	0.3214	0.3362
	0.3207	0.3462
	0.3292	0.3539
	0.3293	0.3424

	x	y
57C	0.3293	0.3424
	0.3292	0.3539
	0.3376	0.3616
	0.3371	0.349
57D	0.3294	0.3306
	0.3293	0.3424
	0.3371	0.349
50A	0.3366	0.3369
	0.3371	0.349
	0.3451	0.3554
	0.344	0.3428
50B	0.3371	0.349
	0.3376	0.3616
	0.3463	0.3687
	0.3451	0.3554
50C	0.3451	0.3554
	0.3463	0.3687
	0.3551	0.376
	0.3533	0.362
50D	0.344	0.3428
	0.3451	0.3554
	0.3533	0.362
	0.3515	0.3487

Notes :

1. CIE 1931 x,y coordinates is measured with an accuracy of ± 0.005
2. Correlation color temperature is measured with an accuracy of $\pm 200K$



Warm Light Binning (2600~3700K)

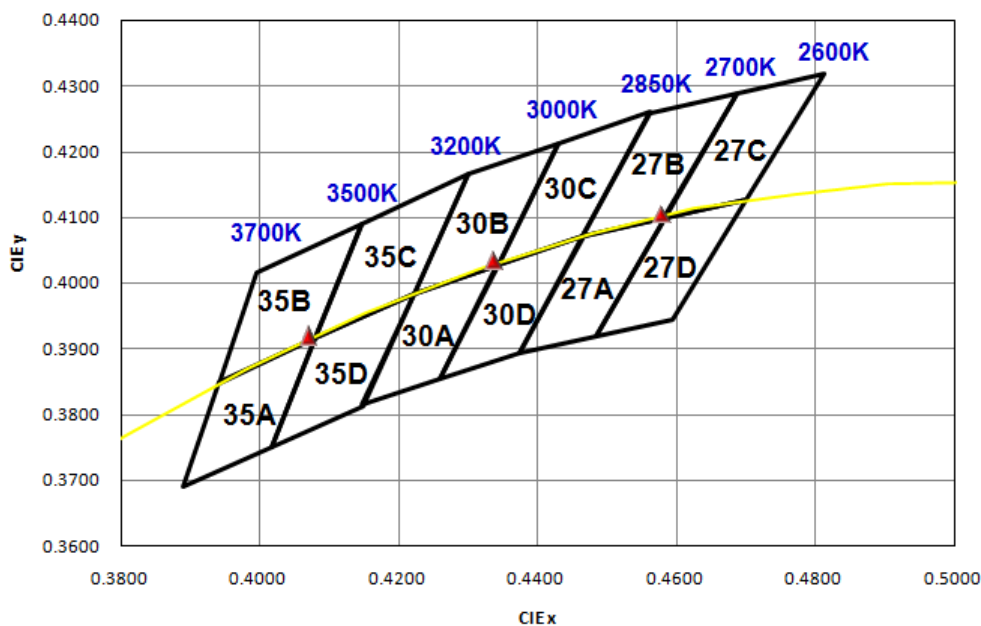

	x	y
35A	0.3889	0.369
	0.3941	0.3848
	0.408	0.3916
	0.4017	0.3751
35B	0.3941	0.3848
	0.3996	0.4015
	0.4146	0.4089
35C	0.408	0.3916
	0.4146	0.4089
	0.4299	0.4165
	0.4221	0.3984
35D	0.4017	0.3751
	0.408	0.3916
	0.4221	0.3984
	0.4147	0.3814
30A	0.4147	0.3814
	0.4221	0.3984
	0.4342	0.4028
	0.4259	0.3853
30B	0.4221	0.3984
	0.4299	0.4165
	0.443	0.4212
	0.4342	0.4028

	x	y
30C	0.4342	0.4028
	0.443	0.4212
	0.4562	0.426
	0.4465	0.4071
30D	0.4259	0.3853
	0.4342	0.4028
	0.4465	0.4071
	0.4373	0.3893
27A	0.4373	0.3893
	0.4465	0.4071
	0.4582	0.4099
	0.4483	0.3919
27B	0.4465	0.4071
	0.4562	0.426
	0.4687	0.4289
	0.4582	0.4099
27C	0.4582	0.4099
	0.4687	0.4289
	0.4813	0.4319
	0.4700	0.4126
27D	0.4483	0.3919
	0.4582	0.4099
	0.4700	0.4126
	0.4593	0.3944

Wavelength Characteristics, $T_j=25^\circ\text{C}$

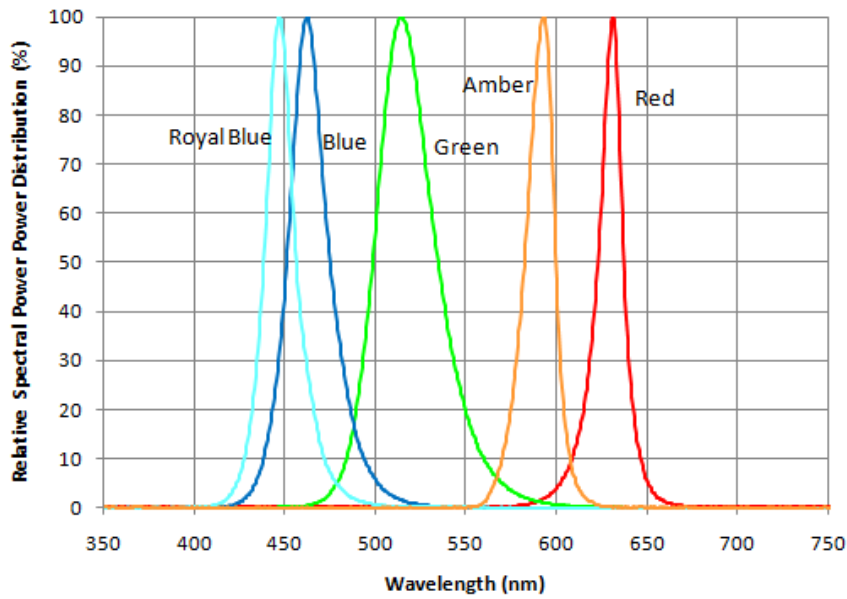

Figure 1a. Relative Intensity vs. Wavelength

White Color Spectrum

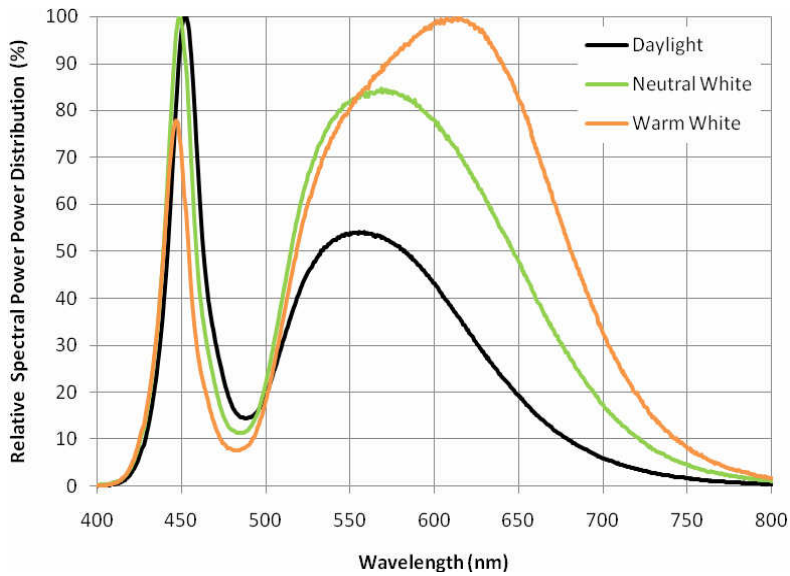

Figure 1b. Relative Intensity vs. Spectrum

Light Output Characteristics Over Temperature

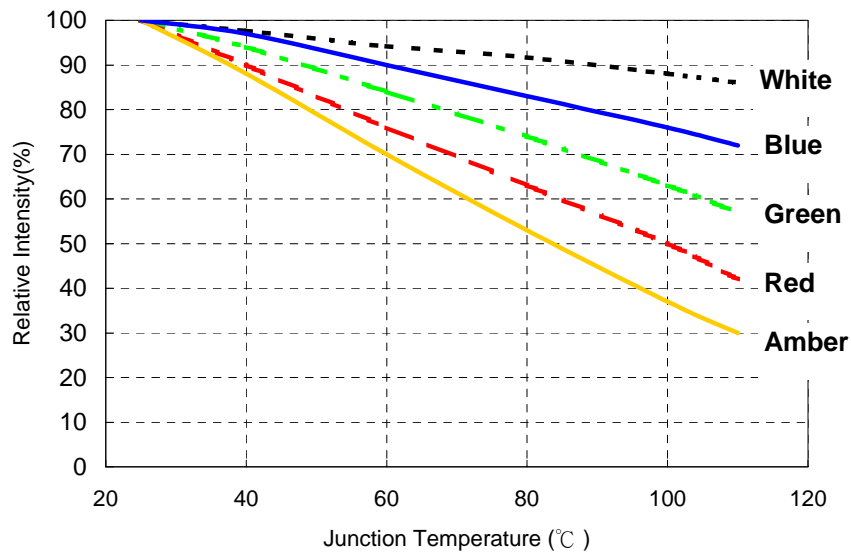

Figure 2a. Relative Light Output vs. Junction Temperature

Typical Representative Spatial Radiation Pattern

Lambertian Radiation Pattern

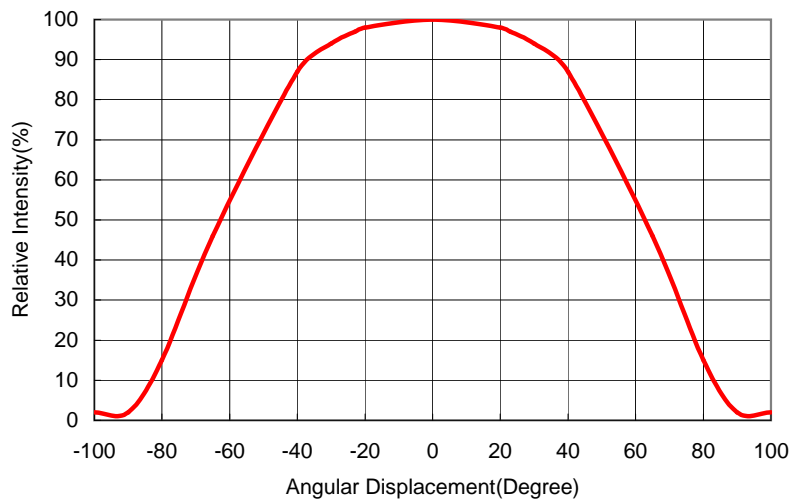

Fig 2b. Typical Representative Spatial Radiation Pattern for White, Warm White, Blue, Green, Amber, and Red.

Forward Current Characteristics, $T_j=25^\circ\text{C}$

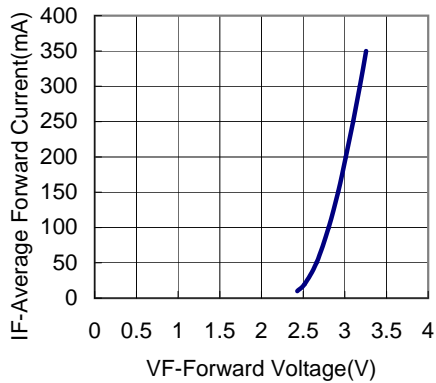

Fig 3a. Forward Current vs. Forward Voltage for White, Warm White, Blue and Green.

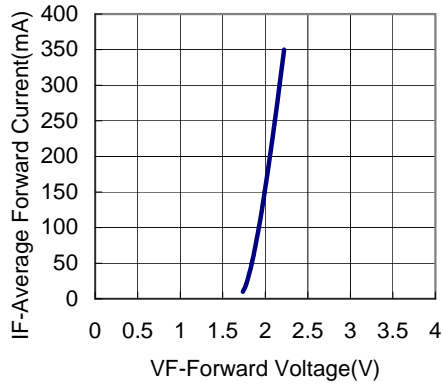

Fig 3b. Forward Current vs. Forward Voltage for Amber, and Red.

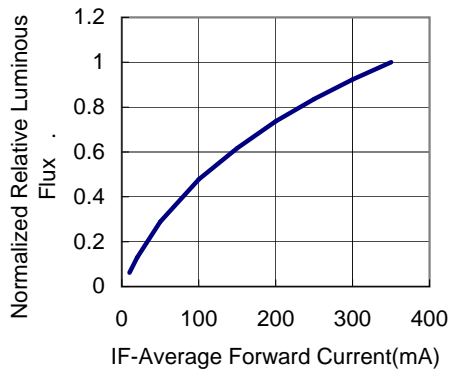

Fig 4a. Relative Luminous Flux vs. Forward Current for White, Warm White, Blue and Green at $T_j=25^\circ\text{C}$ maintained.

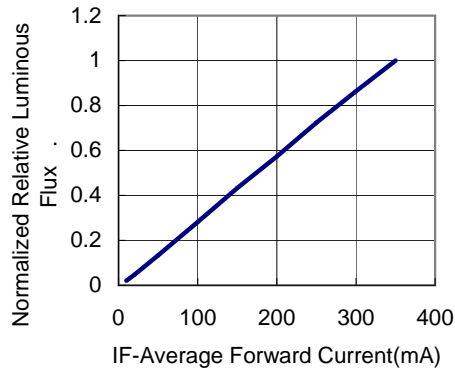

Fig 4b. Relative Luminous Flux vs. Forward Current for Amber, Red at $T_j=25^\circ\text{C}$ maintained.

Current Derating Curves

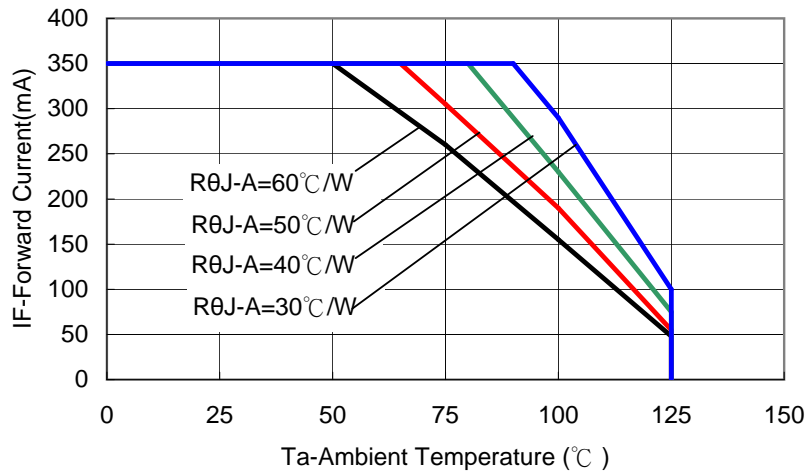

Fig 5a. Maximum Forward Current vs. Ambient Temperature. Derating based on $T_{jMAX}=125^{\circ}\text{C}$ for White, Warm White, Blue and Green.

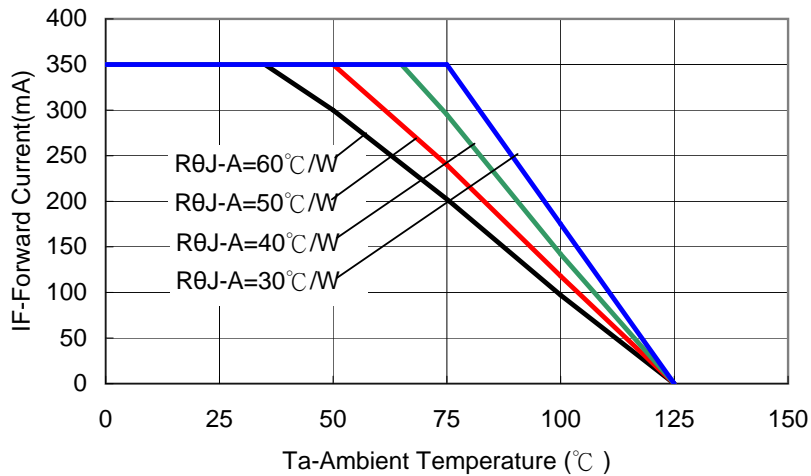

Fig 5b. Maximum Forward Current vs. Ambient Temperature. Derating based on $T_{jMAX}=125^{\circ}\text{C}$ for Amber, and Red.

Recommended Soldering Pads

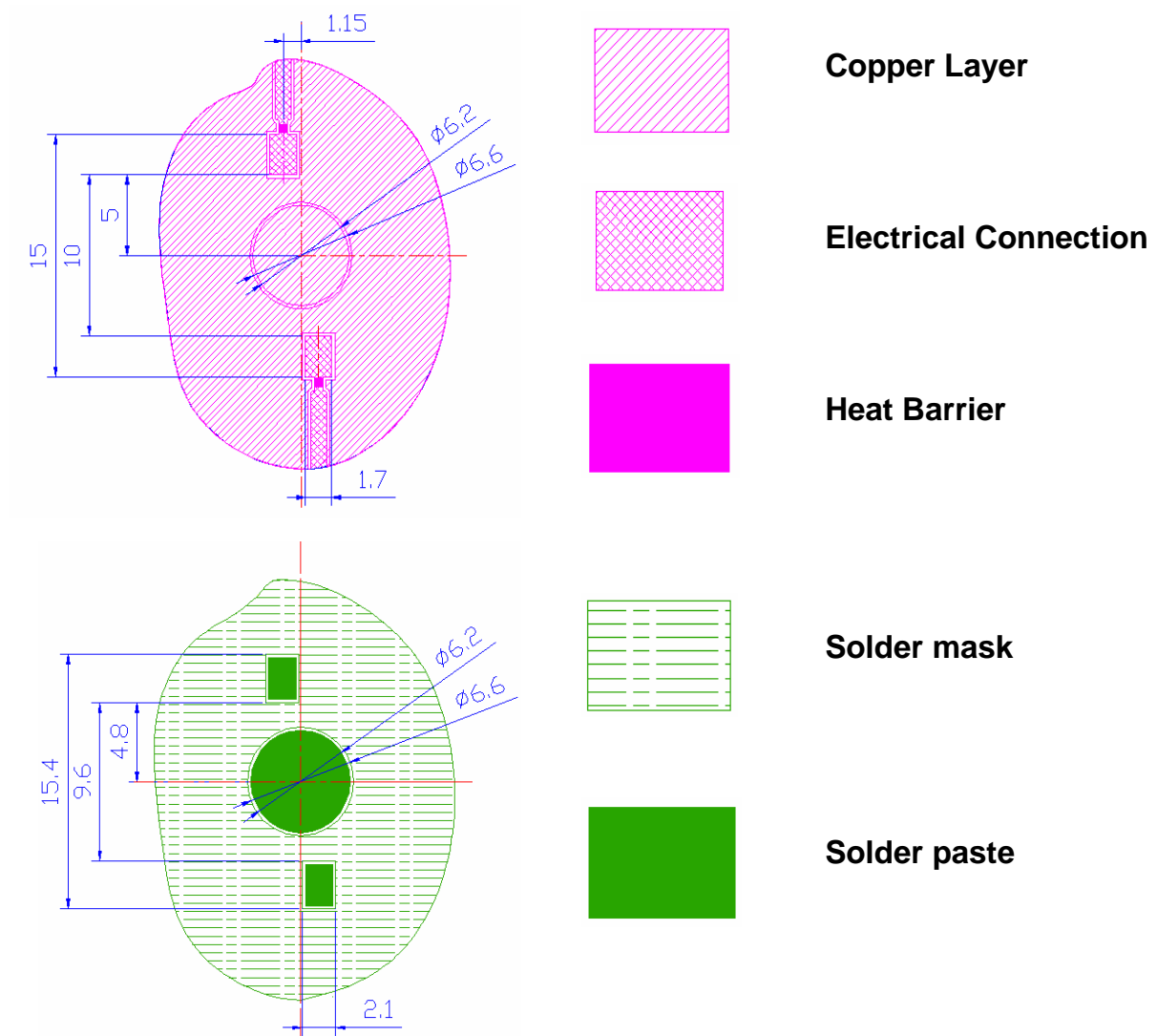

Fig 6. Recommended Solder pads dimension.

Recommend IR Reflow Condition

Reflow Soldering		
	Lead Solder	Lead-free Solder
Pre-heat	120~150°C	180~200°C
Pre-heat time	120 sec. Max.	120 sec. Max.
Peak temperature	240°C Max.	260°C Max.
Soldering time	10 sec. Max.	10 sec. Max.
Condition	refer to temperature-profile (A)	refer to temperature-profile (B) (N ₂ reflow is recommended.)

- After reflow soldering rapid cooling should be avoided.

Temperature-profile (Surface of MCPCB)

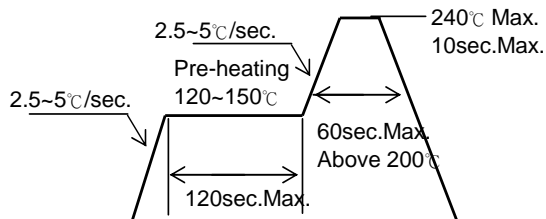

Figure 8a. Lead Solder Temperature Profile

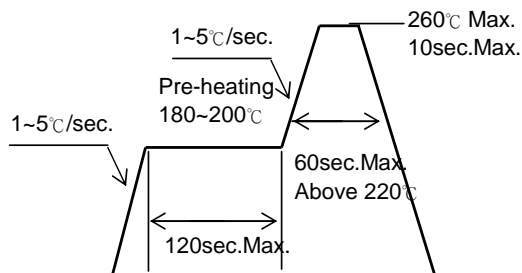
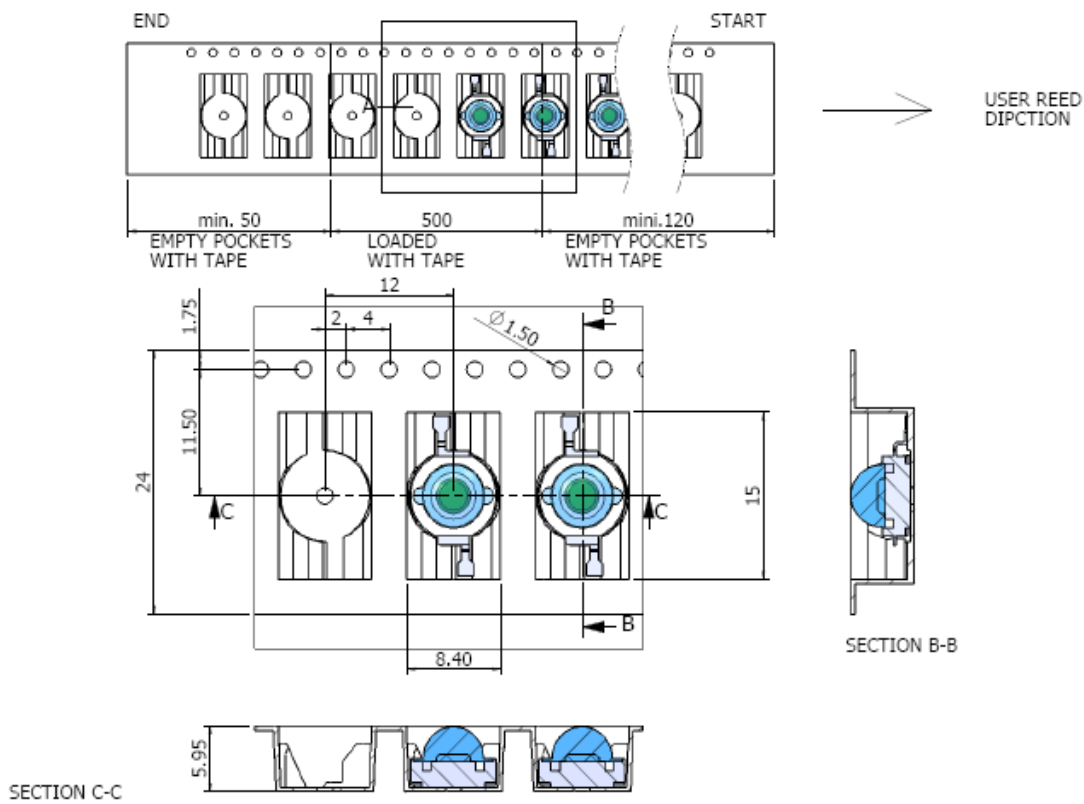

Figure 8b. Lead-free Solder Temperature Profile

- Occasionally there is a brightness decrease caused by the influence of heat or ambient during air reflow. It is recommended that the User use the nitrogen reflow method.
- Repairing should not be done after the LEDs have been soldered.
- Reflow soldering should not be done more than two times.
- When soldering, do not put stress on the LEDs during heating.
- After soldering, do not warp the circuit board.

Emitter Pocket Tape Packaging



200pcs / Reel

Tube Packaging

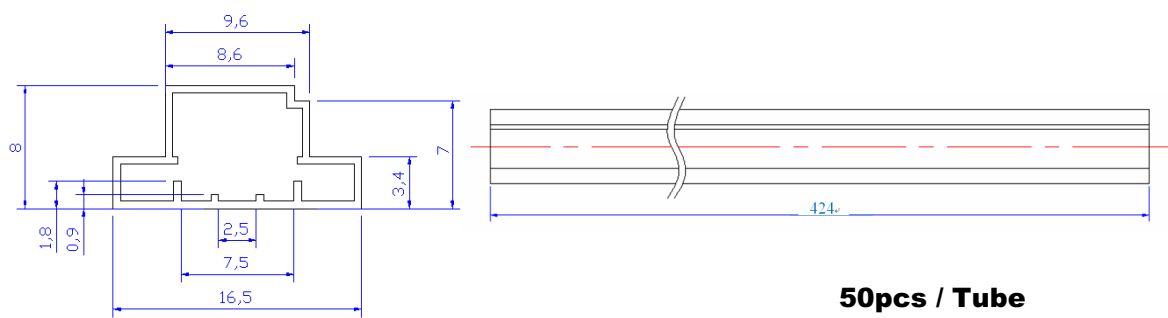

Emitter Reel Packaging

